



Frequency Range:

32.768 kHz

Features:

- High Reliability & Low Cost Unit
- Compact Design
- RoHS Compliant
- Lead Free
- 260°C Reflow Compatible



Actual Size



QUARTZ
CRYSTALS

■ Standard Specifications

Item	MT (1.6x1.0)
Frequency Range	32.768kHz
Equivalent Series Resistance (ESR)	90kΩ Max
Frequency Tolerance @ 25 °C	±20ppm, ±50ppm
Temperature Coefficient	-0.045 ppm /°C ² Max
Operating Temperature Range	-40 °C to +85 °C
Operable Temperature Range	-55 °C to +125 °C
Turnover Temperature	25 °C ± 5 °C
Load Capacitance	9.0pF, 12.5pF are standard
Drive Level	0.1μW Typ. (0.5μW Max)
Shunt Capacitance	2.0pF Max
Ageing	±3ppm/year

Note:

1. Manufacturer reserves the right to change the specification and content of this product for improvement without notification.
2. Custom specification is welcome. Please contact our sales representative for further details.
3. If the crystal is intended for applications which have direct impact on human life and properties, and require a high degree of reliability and safety concerns, customers must provide full information such as but not limit to the application, electrical and reliability specification at the inquiry beginning stage.
4. Customers have to agree to the "Guideline for handling crystal units" and "Standard Terms and Condition of Sales" which is printed this catalog before placing orders to our company or our distributors. There are also unpredictable factors such as applied condition, oscillation margin and etc and customers must check them beforehand. In case of queries, please do not fail to send inquiry to our company before ordering.



■ Dimensions (mm)

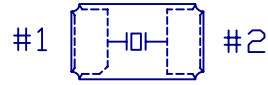
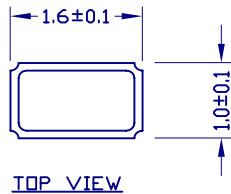

REMARK: 1,2 -CRYSTAL

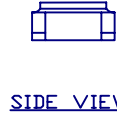
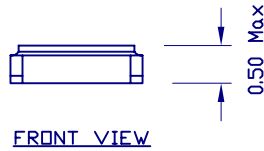

MARKING INFORMATION

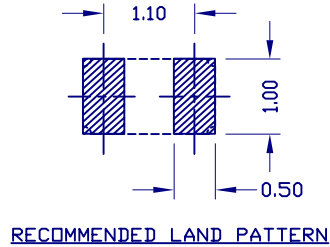
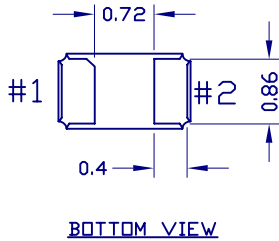

QUARTZ CRYSTALS

■ Tape & Reel (mm)

FEED DIRECTION →

* Recommended no circuitry or trace in between the solder pads

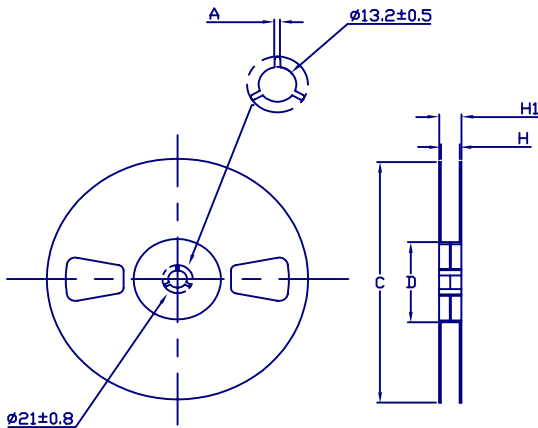
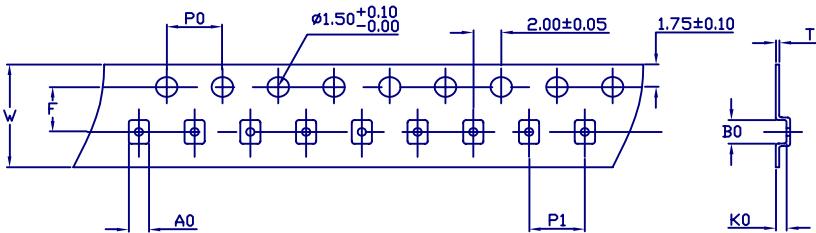

		1.6x1.0 - MT CERAMIC SMD TUNING FORK CRYSTAL
T A P E	W	8.0±0.2
	P1	4.0±0.1
	A0	1.25±0.10
	B0	1.85±0.10
	K0	0.7±0.1
	P0	4.0±0.1
	10P0	40.0±0.2
	F	3.50±0.05
R E E L	T1	0.25±0.05
	C	ø178 ⁺³ ₋₃
	A	2.5 ^{+0.5} ₋₀
	D	ø60.2±0.5
	H1	11.4±1.0
STANDARD PACKING QTY/REEL		5000PCS
MAXIMUM PACKING QTY/REEL		5000PCS